

design Antonio Citterio

divani componibili / modular sofas

2010 **Ray**





RYL249S RYL275

RY83



Ray è un sistema modulare a partire da elementi lineari, chaise longue, terminali e pouf con fodera che generano configurazioni anche angolari e a penisola. Ray lavora sul tema del comfort e sui dettagli sartoriali che si esprimono in particolare nella cucitura a punto cavallo, in tinta o a contrasto, che arricchisce

i rivestimenti sfoderabili. Nasce in due profondità, una più tradizionale ed una extra large, per chi desidera posizioni di autentico relax. Completa il sistema la poltrona imbottita, dotata di cuscino schienale e dalle medesime impunture a punto cavallo del divano.

Ray is a modular system based on linear elements, chaise longue, terminal elements and ottomans with slip cover, which can be used to create corner and peninsula configurations. Ray focuses on comfort and tailoring details, particularly the blanket stitch, in the same or a contrast colour, which enhance

removable covers. Created in two depths, this sofa is available in a more traditional version and an extra large version for those in search of true relax. The upholstered armchair completes the system, including a back cushion and the same blanket stitch as the sofa.





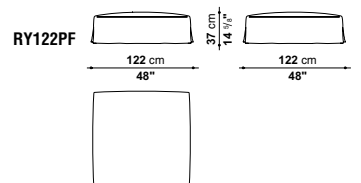
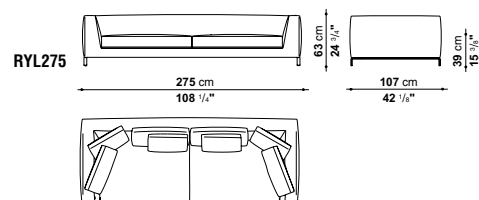
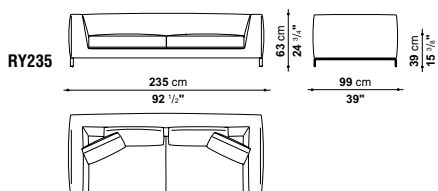
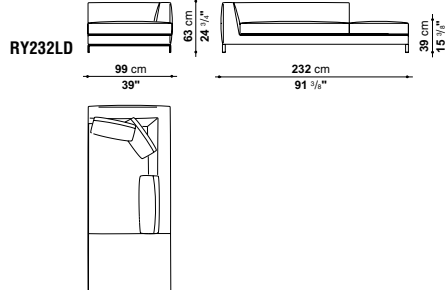
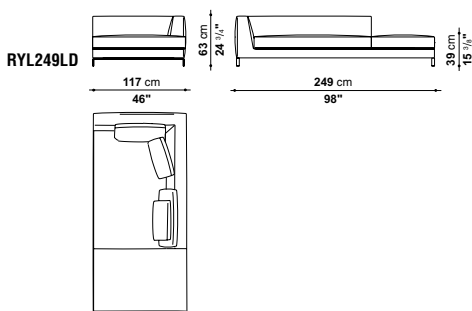
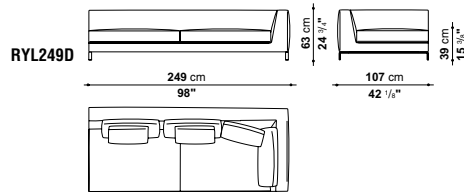
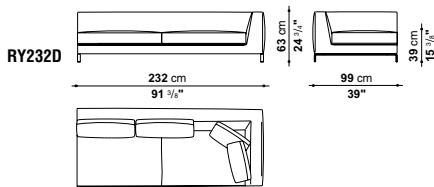
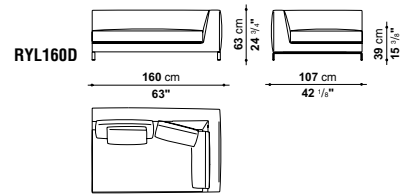
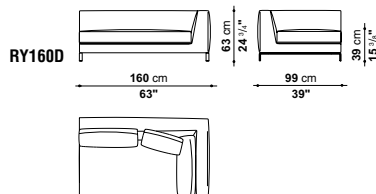
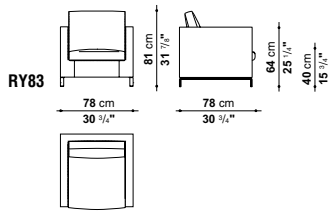

<b>Telaio interno</b>	tubolari e profilati d'acciaio	<b>Internal frame</b>	tubular steel and steel profiles
<b>Imbottitura telaio interno</b>	schiuma di poliuretano flessibile a freddo Bayfit® (Bayer®), fodera in fibra di poliestere	<b>Internal frame upholstery</b>	Bayfit® (Bayer®) flexible cold shaped polyurethane foam, polyester fibre cover
<b>Imbottitura telaio interno pouf</b>	poliuretano sagomato a densità differenziata, fodera in fibra di poliestere	<b>Ottoman internal frame upholstery</b>	shaped polyurethane of different density, polyester fibre cover
<b>Imbottitura cuscini sedile</b>	poliuretano sagomato a densità differenziata, fibra di poliestere, fodera in fibra di poliestere e cotone	<b>Seat cushions upholstery</b>	shaped polyurethane of different density, polyester fibre, polyester and cotton fibre cover
<b>Piedini</b>	fusione d'alluminio verniciato nickel bronzato	<b>Feet</b>	bronzed nickel painted die-cast aluminium
<b>Piedini pouf</b>	materiale plastico nero	<b>Ottoman feet</b>	black plastic material
<b>Puntali</b>	materiale termoplastico	<b>Ferrules</b>	thermoplastic material
<b>Rivestimento</b>	tessuto o pelle	<b>Cover</b>	fabric or leather