

Sushi outdoor Alucompact®

Designed by Bartoli Studio

Fixed table with aluminium structure and slatted top in Alucompact® layered laminate. Alucompact® is a high-pressure layered laminate with aluminium sheeting inserted during the layering phase, which provides strong structural stability and excellent resistance to impact, detergents, alcohol and UV rays.

Finish of structure:

Anodised aluminium

Leg finish:

Anodised aluminium

Aluminium with white lacquer

Aluminium with anthracite grey lacquer

Finish of top:

White laminate

Grey laminate

Anthracite grey laminate

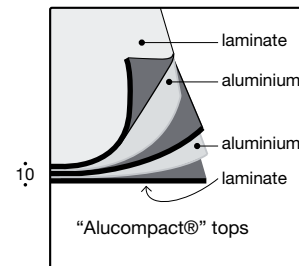

 Tables that extend to more than 250 cm have a top that slightly bends, which complies with accepted quality standards.

Fixed (II)

Code	Length (cm.)	Depth	Finish of legs	Finish of top	Vol.
01SUS40F	161	90	aluminium	laminate	0.33
			lacquer	laminate	
01SUS41F	180	90	aluminium	laminate	0.37
			lacquer	laminate	
01SUS42F	215	90	aluminium	laminate	0.48
			lacquer	laminate	
01SUS44F	270	90	aluminium	laminate	0.61
			lacquer	laminate	
01SUS46F	139	136	aluminium	laminate	0.49
			lacquer	laminate	

Nr. packages 1

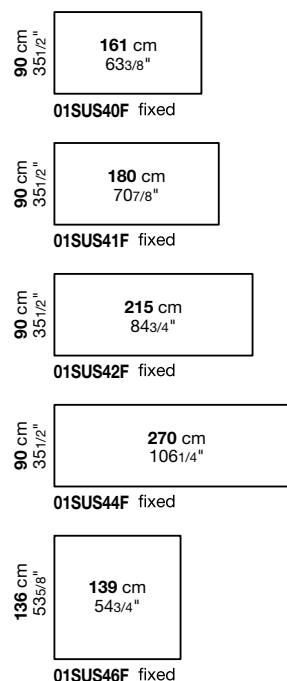
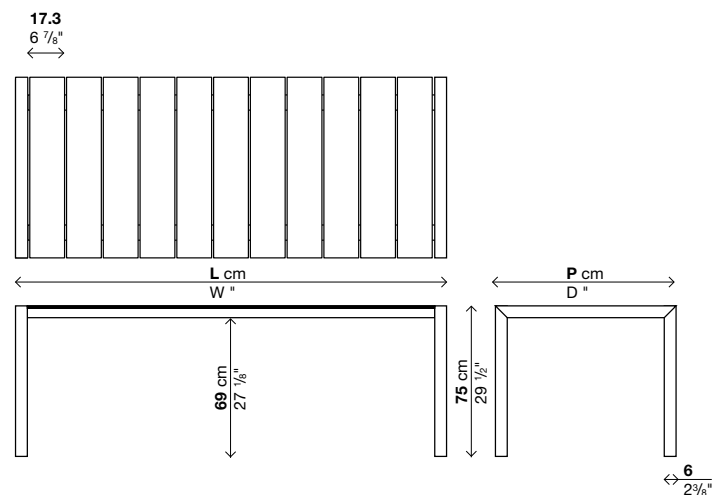

Sushi outdoor bench

Designed by Bartoli Studio

An outdoor bench with anodized aluminium frame and slatted seat in Alucompact® layered laminate. Alucompact® is a high-pressure layered laminate with aluminium sheeting inserted during the layering phase, which provides strong structural stability and excellent resistance to impact, detergents, alcohol and UV rays.

Finish of structure:

Anodised aluminium

Leg finish:

Anodised aluminium

Aluminium with white lacquer

Aluminium with anthracite grey lacquer

Finish of top:

White laminate

Grey laminate

Anthracite grey laminate

Bench

Code	Length (cm.)	Depth	Finish of legs	Finish of top	Vol.
05SUS50	123	41	aluminium	laminate	0.14
			lacquer	laminate	
05SUS51	144	41	aluminium	laminate	0.16
			lacquer	laminate	
05SUS52	162	41	aluminium	laminate	0.18
			lacquer	laminate	

Nr. packages 1

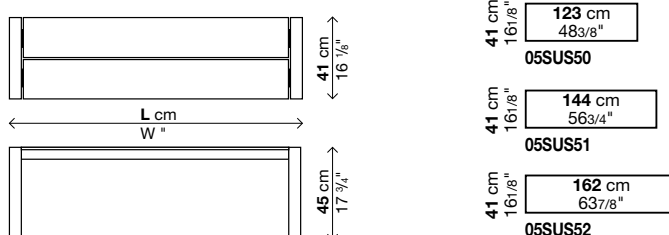

Finishes

Finiture metallo

Metal finish / Metallausführungen / Acabados metal / Finitions métal

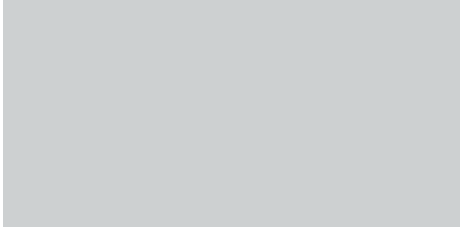

Alluminio anodizzato / Anodised aluminium / Eloxiertes Aluminium / Aluminio anodizado / Aluminium anodisé



Bianco / White / Weiß / Blanco / Blanc



Grigio antracite / Anthracite grey / Grau anthrazit / Gris antracita / Gris anthracite

Laminati Alucompact®

Alucompact® laminates / Laminate Alucompact® / Laminados Alucompact® / Stratifiés Alucompact®

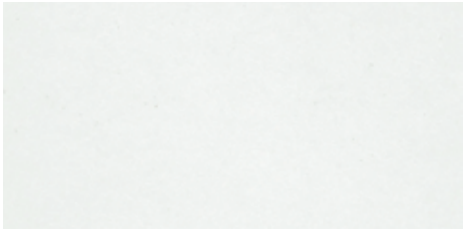

Bianco / White / Weiß / Blanco / Blanc



Grigio / Grey / Grau / Gris / Gris



Grigio antracite / Anthracite grey / Grau anthrazit / Gris antracita / Gris anthracite